

# Signature

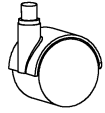

A

5PCS

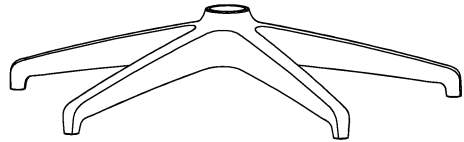

B

1PCS

①

B 1PCS

A 5PCS

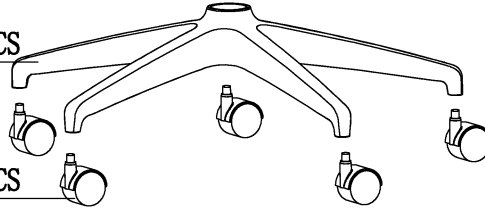

C 1PCS

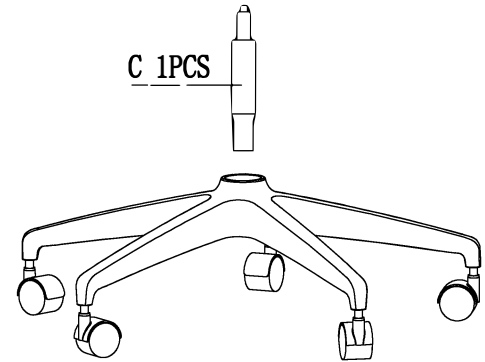

②



C

1PCS

D 1PCS

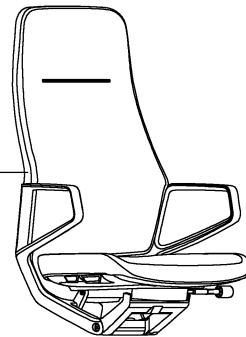

D

1PCS

③

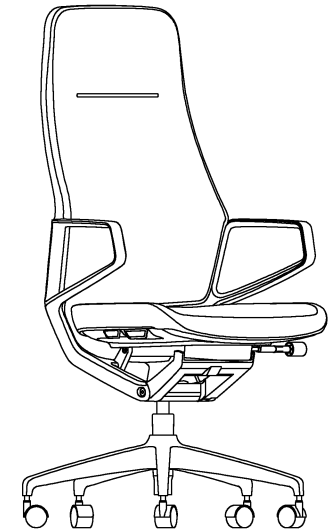
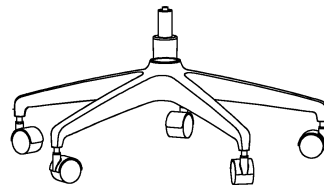

④